

CARTOONS

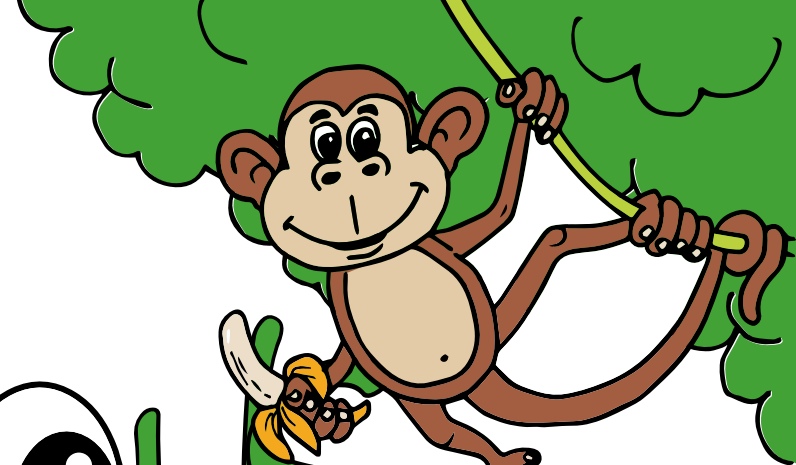



CARTOONS



Più natura nell'area gioco...

con **CARTOONS**, la nuova linea di **TLF**, dove tutto è possibile!

Le sue strutture ludiche sono state progettate e realizzate coniugando l'utilizzo di materiali sostenibili e un design innovativo, creando un'atmosfera magica e stimolante che permette la perfetta integrazione con l'ambiente circostante.

Ideali per scuole e parchi, le attrezzature **CARTOONS** offrono ai bambini un'esperienza di gioco unica ed inclusiva, immersi in un fantasioso e stimolante ambiente ispirato alle forme della natura.

CARTOONS

Attraverso la nuova linea **CARTOONS**, TLF propone un innovativo approccio per la fruizione degli spazi ludici di comunità focalizzati su quattro aspetti principali

FANTASIA

cibo per la mente

La 'scenografia' rappresenta una delle filosofie cardine del gioco, finalizzata a creare l'atmosfera e lo spazio ideale per permettere al bambino di volare con la fantasia e la creatività in immaginari giochi di ruolo da poter condividere con gli amici. Un vero e proprio mondo che da immaginario si trasforma in reale, rappresentando il trampolino di lancio per balzare verso realtà fantastiche e mondi invisibili, frutti della propria immaginazione.

MOVIMENTO

energia per il corpo

Diversi accessori tradizionali per salite e discese dalle strutture permettono un gioco dinamico che, a seconda della difficoltà, stimola la crescita del bambino creando le condizioni per una continua sfida; tutto nella sicurezza garantita dal rispetto delle normative vigenti e, soprattutto, dal buon senso.

INCLUSIVITÀ

giocare insieme

La linea è studiata per essere fruibile da tutti i bambini, indipendentemente dalle loro capacità, con 'situazioni' che possono adattarsi alle diverse esigenze. Colori accoglienti e rassicuranti di un mondo, quello dei cartoni animati, conosciuto e tranquillizzante che permette di usufruire di spazi aperti o raccolti per andare incontro alle molteplici necessità e/o sensibilità di relazione.

MATERIALI

naturali e riciclabili

Natura e riciclo sono punti fondamentali di questa linea: Il **Legno di pino**, per una visione calda ed equilibrata; **Plastica HDPE**, per donare colore e carattere; **Metalli pregiati** (acciaio inox e alluminio) per resistenza e igiene. Tutti questi materiali sono di prima qualità e rispondono alle più stringenti normative di settore.





RISPETTO

CORAGGIO

LEADERSHIP



Materiali e componenti

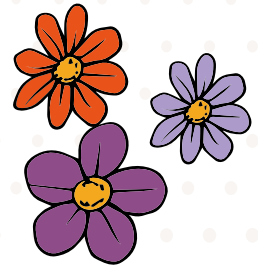

Legno

Pino Silvestre Scandinavo certificato **FSC®** o **PEFC™** impregnato a pressione in autoclave con soluzione preservante all'acqua atossica, certificata ed efficace contro gli xilofagi. I **montanti, in legno lamellare** con speciale profilo a quadrifoglio per ridurre i fenomeni di fessurazione (sez. 95x95 mm), sono ulteriormente trattati con impregnante all'acqua pigmentato (certificato **CAM Arredo urbano**) per conferire colorazione di rifinitura e protezione contro i raggi UV (ingrigimento) assicurando una maggior durabilità.

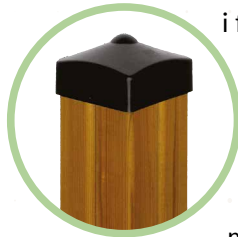

Hdpe

Di spessore 19 mm e disponibile in un'ampia gamma di colori, viene usato per realizzare le pannellature; è un materiale resistente e indistruttibile che non necessita di manutenzione, resistente e di facile pulizia. È composto da materiale plastico riciclato all'80% ed è a sua volta riciclabile.

Scivoli in PE – Eco

Gli scivoli sono realizzati in Polietilene (PE) riciclato al 100%. Anche questa scelta rafforza la filosofia Aziendale di integrare l'economia circolare nel nostro processo produttivo e di adattarla alle esigenze del mercato.

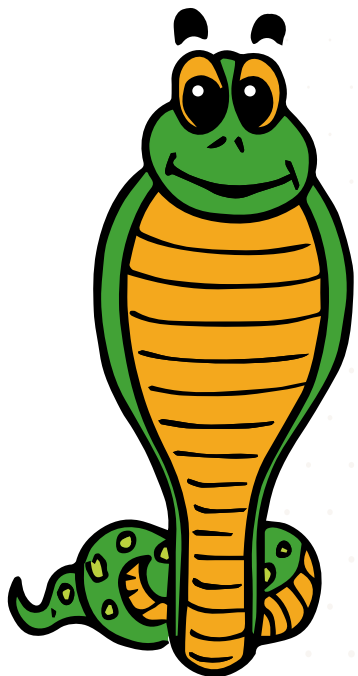

Alluminio

Per la versione in alluminio i **montanti sono in lega di alluminio** estruso tipo EN-AW 6060 T6 riciclato al 70% circa. Hanno una sezione di 95 x 95 mm con angoli stondati per maggiore sicurezza, pareti esterne di spessore 2 mm e rinforzi interni per garantire maggiore rigidità e resistenza. Le superfici esterne hanno un trattamento superficiale decorativo ed anticorrosivo che consiste in una anodizzazione color argento effetto spazzolato. I **piani e le pedane di calpestio** sono in **HPL** antiscivolo di spessore 10 mm certificati **FSC®**.

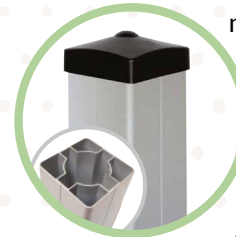

Acciaio inox

I tubolari in acciaio inossidabile (diametro 38 mm sp.2mm di tipo AISI 304) vengono usati per la realizzazione di spalliere e pertiche; l'utilizzo di questi, in alternativa dell'acciaio zincato, garantisce una maggiore durabilità e pulizia delle superfici in quanto totalmente prive di scorie di lavorazione taglienti e/o abrasive che potrebbero rappresentare un pericolo durante l'uso e la manipolazione. Anche questo materiale risulta totalmente riciclabile.

Acciaio "nero"

Viteria e bulloneria in acciaio nero con elevata resistenza alla corrosione (GEOMET BLACK®) nel caso di applicazioni a vista, o protezione con tappi stondati in nylon nero.

Il Bosco di Paul

 CAAB3101

COMPONENTI

Scivoli: H 150 e H 90 cm

Pertica: H 150 cm

Pertica risalita: H 150 cm

Ponte tunnel: L 150 cm

Monkey bar: L 150 cm

Sartia: H 90 cm

Pannelli interattivi



1,48h



m² 62



m² 51



m² 56,25

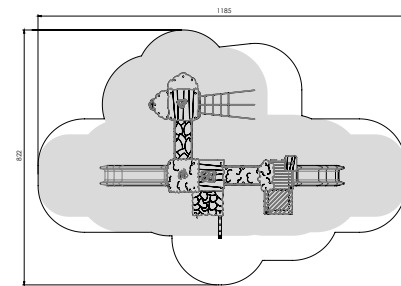

Versione disponibile con montanti in Alluminio e piani in HPL



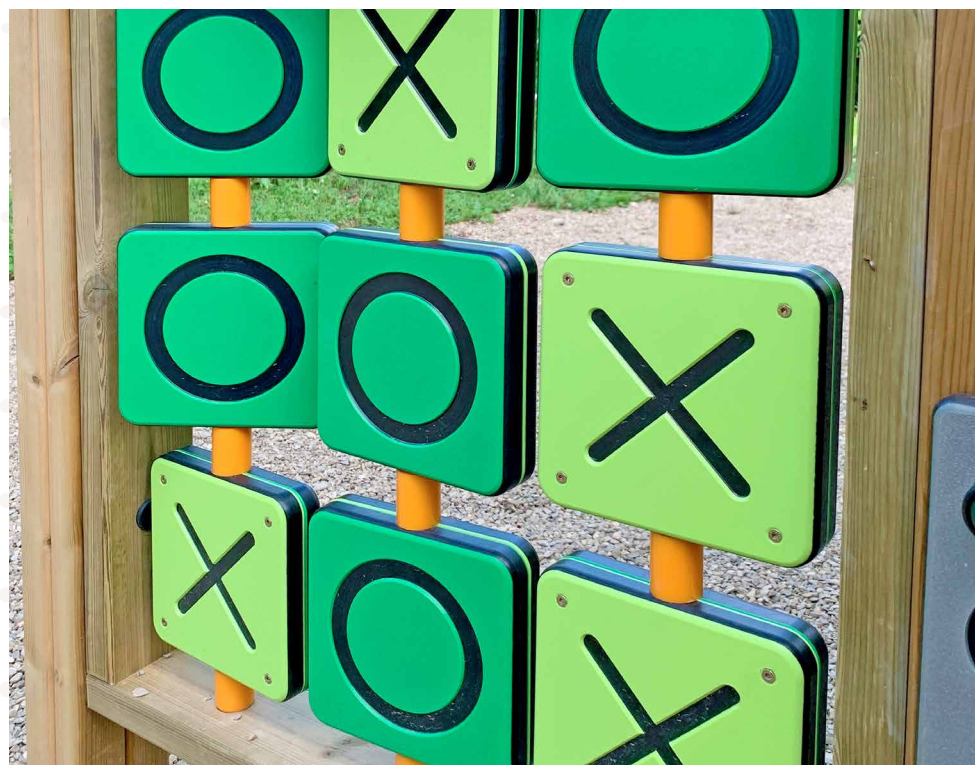
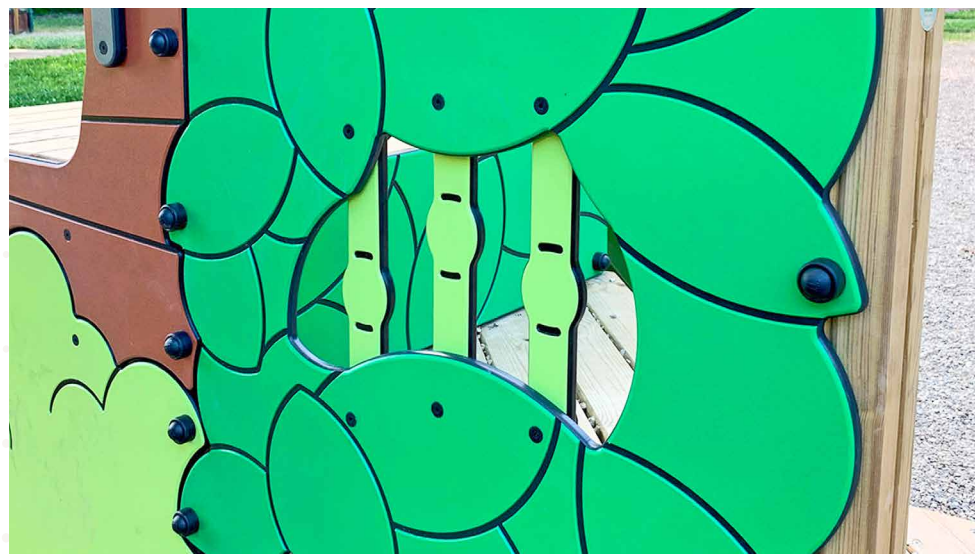

Il Giardino del Vento

CAAB2101

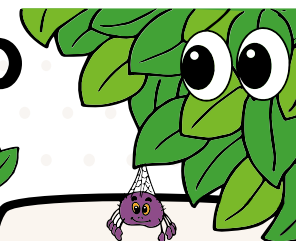

1,48h



m² 48,34



m² 39,86



m² 44

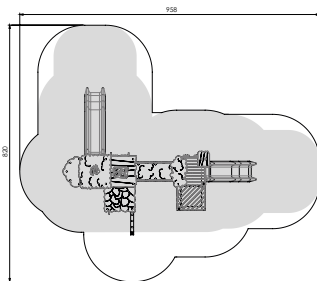

Versione disponibile con montanti in Alluminio e piani in HPL

COMPONENTI

Scivoli: H 150 e H 90 cm

Pertica: H 150 cm

Ponte tunnel: L 150 cm

Pannelli interattivi

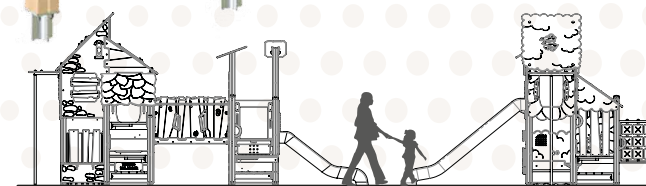



Il Bosco Segreto



CAAB2102

COMPONENTI

Scivoli: H 150 e H 90 cm

Pertica: H 150 cm

Monkey bar: L 150 cm

Pannelli interattivi



1,48h



m² 48,34



m² 39,86



m² 44

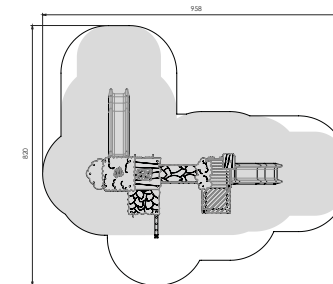



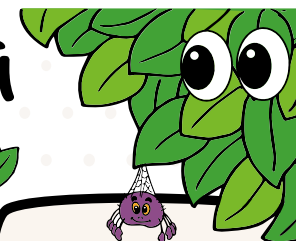
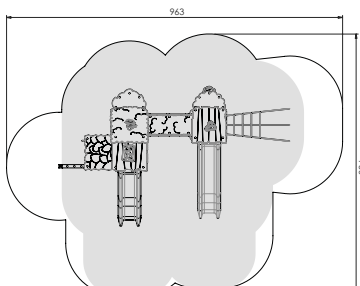

Versione disponibile con montanti in Alluminio e piani in HPL

La Foresta Bambina

CAAB2103 

 1,48h
 m² 51,67
 m² 41,61
 m² 44

Versione disponibile con montanti in Alluminio e piani in HPL

- COMPONENTI**
- Scivoli: H 150 e H 90 cm
 - Pertica: H 150 cm
 - Pertica risalita: H 150 cm
 - Ponte tunnel: L 150 cm
 - Sartia: H 150 cm
 - Pannelli interattivi



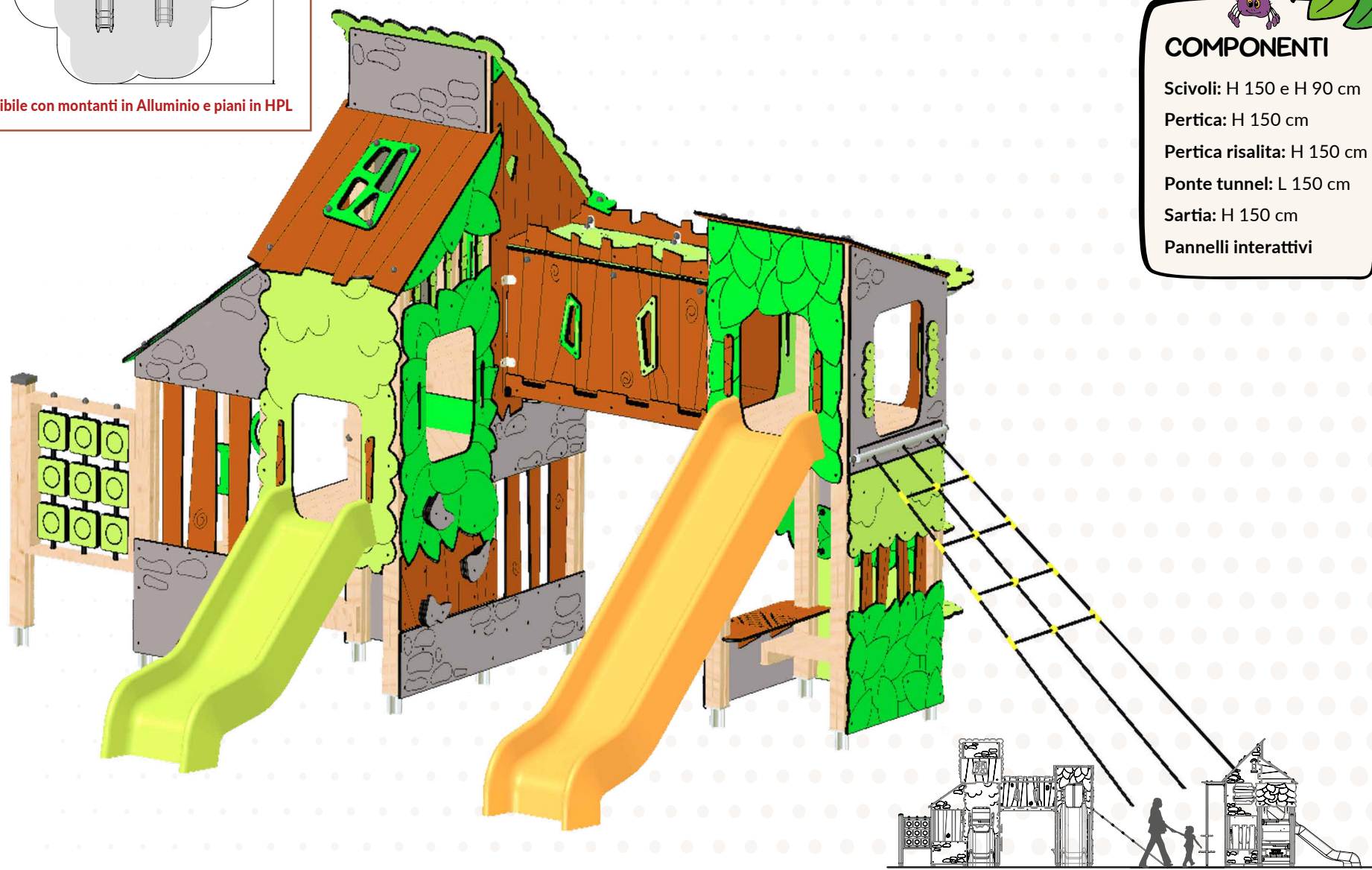

La valle Arcobaleno

 CAAB2104

COMPONENTI

Scivoli: H 150 e H 90 cm

Pertica: H 150 cm

Monkey bar: L 150 cm

Sartia: H 150 cm

Scala

Pannelli interattivi

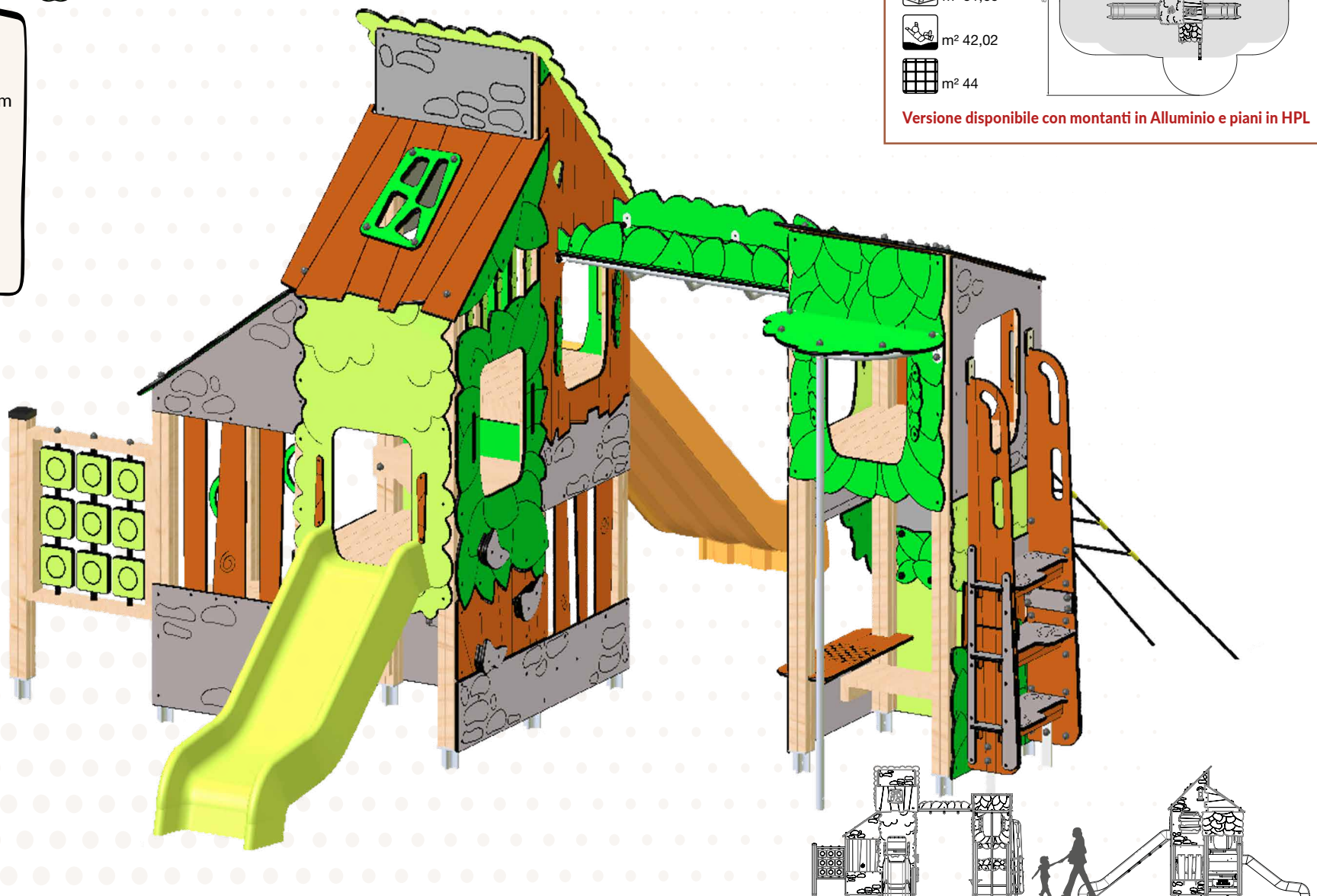

1,48h

m² 51,69

m² 42,02

m² 44

Versione disponibile con montanti in Alluminio e piani in HPL

Il prato del Sorriso

CAAB2105 

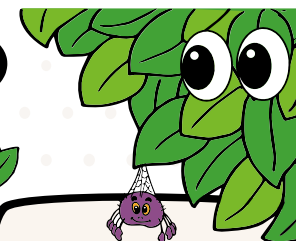

0,88h

m² 39,30

m² 30,69

m² 34

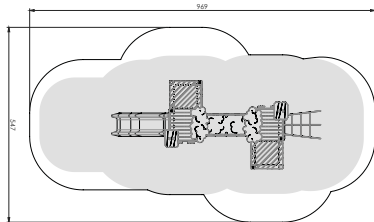

Versione disponibile con montanti in Alluminio e piani in HPL

COMPONENTI

Scivolo: H 90 cm

Sartia: H 90 cm

Ponte tunnel: L 150 cm

Pannelli interattivi

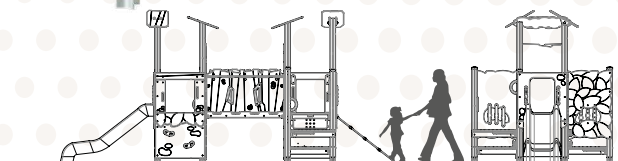
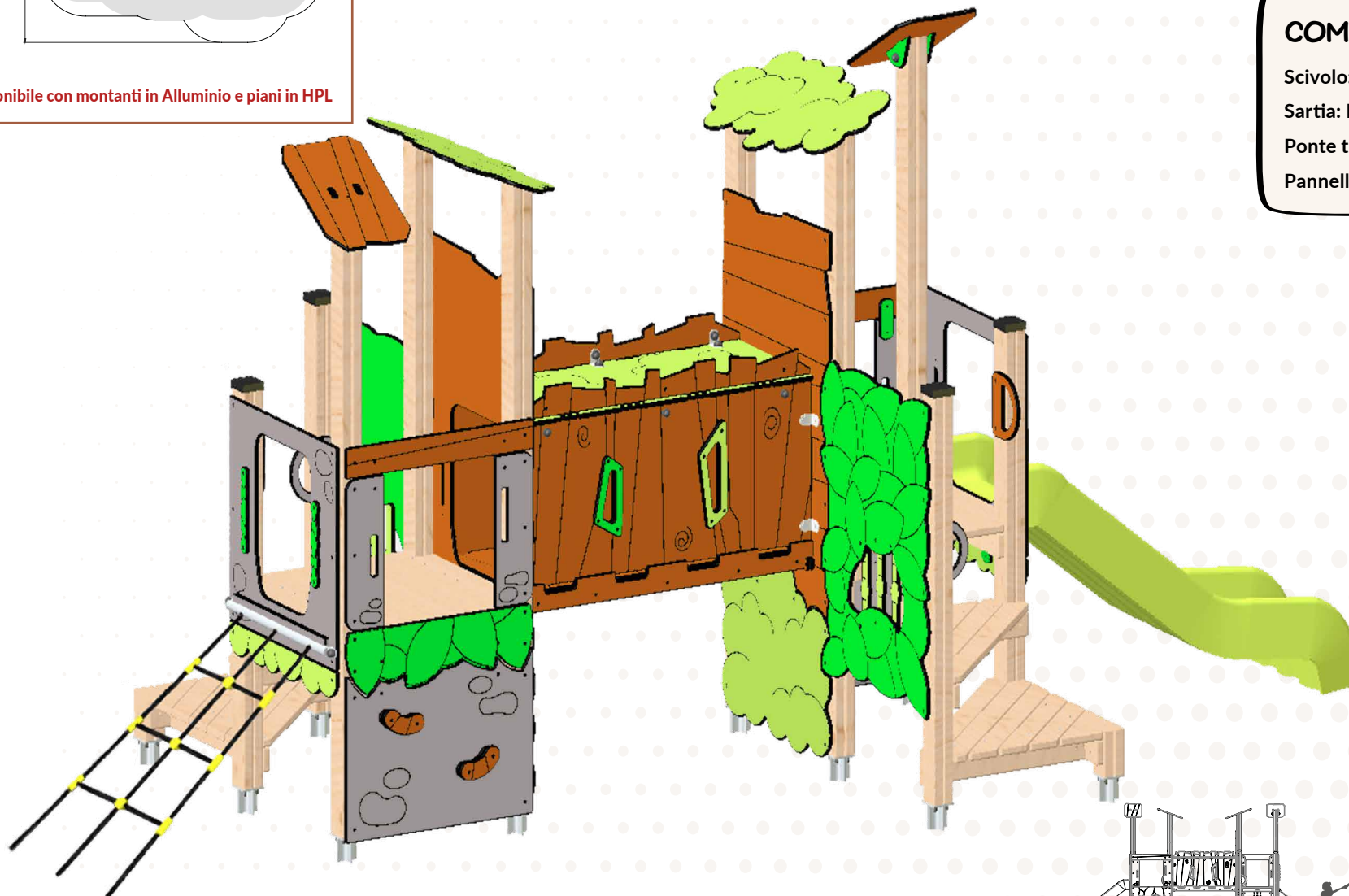

Boscallegro

CAAD1101





COMPONENTI

Scivoli: H 150 e H 90 cm

Pertica: H 150 cm

Pannelli interattivi





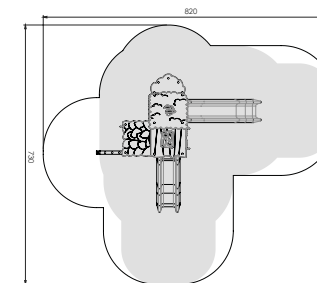



-  1,48h
-  m² 38,10
-  m² 31,04
-  m² 36,50

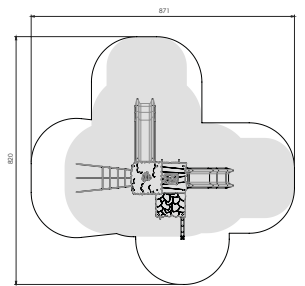

Versione disponibile con montanti in Alluminio e piani in HPL





 1,48h
 m² 44,31
 m² 32,69
 m² 37,50

Versione disponibile con montanti in Alluminio e piani in HPL

Forestella

CAAD1102

COMPONENTI

- Scivoli: H 150 e H 90 cm
- Sartia: H 150 cm
- Pannelli interattivi

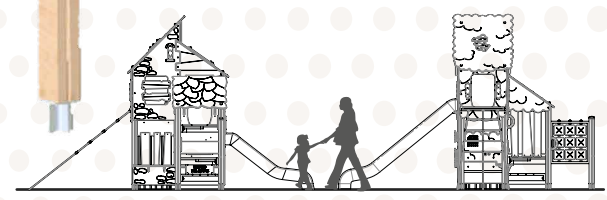
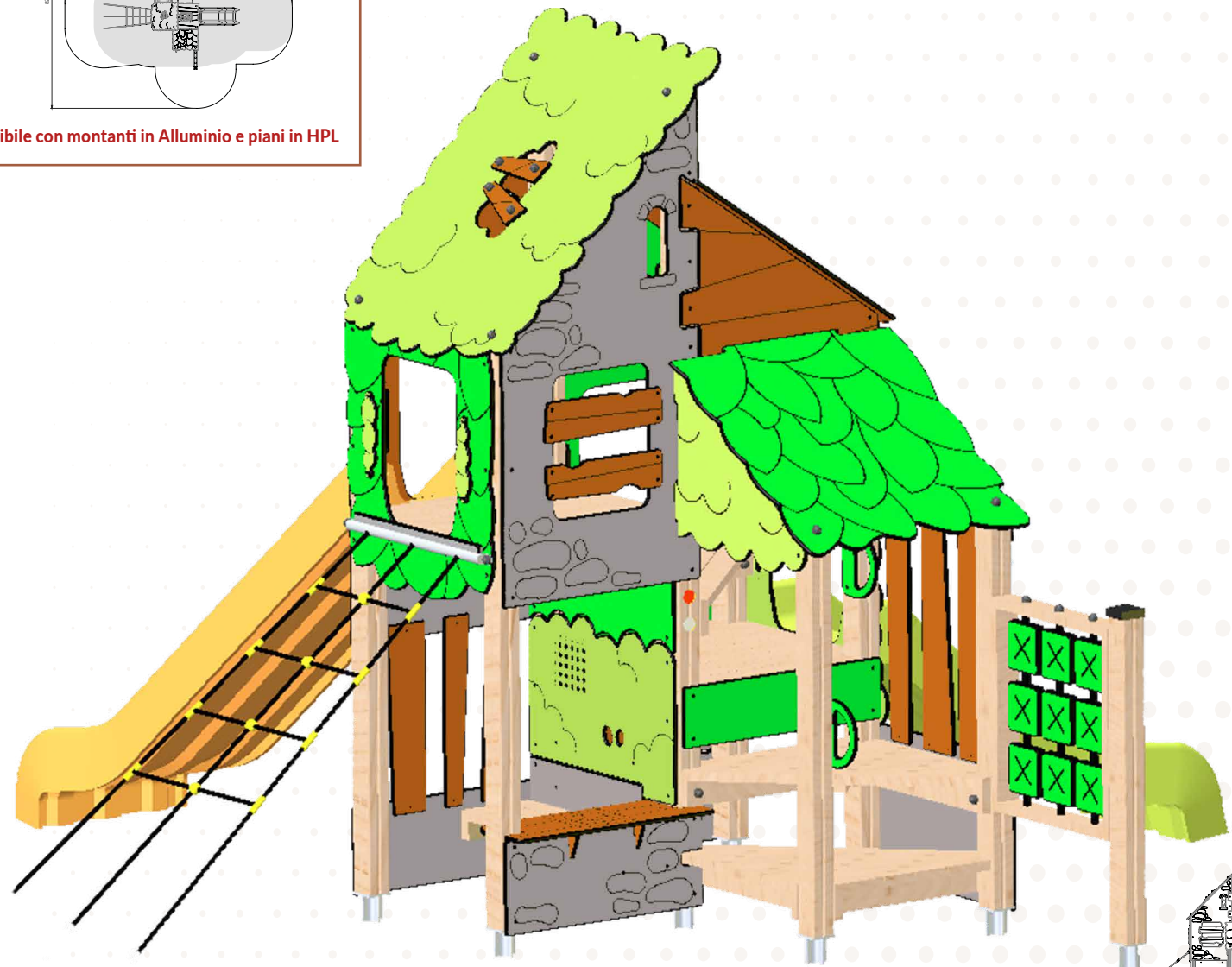



Selvamagica

CAAD1103

COMPONENTI

Scivolo: H 150 cm

Pertica: H 150 cm

Sartia: H 90 cm

Pannelli interattivi

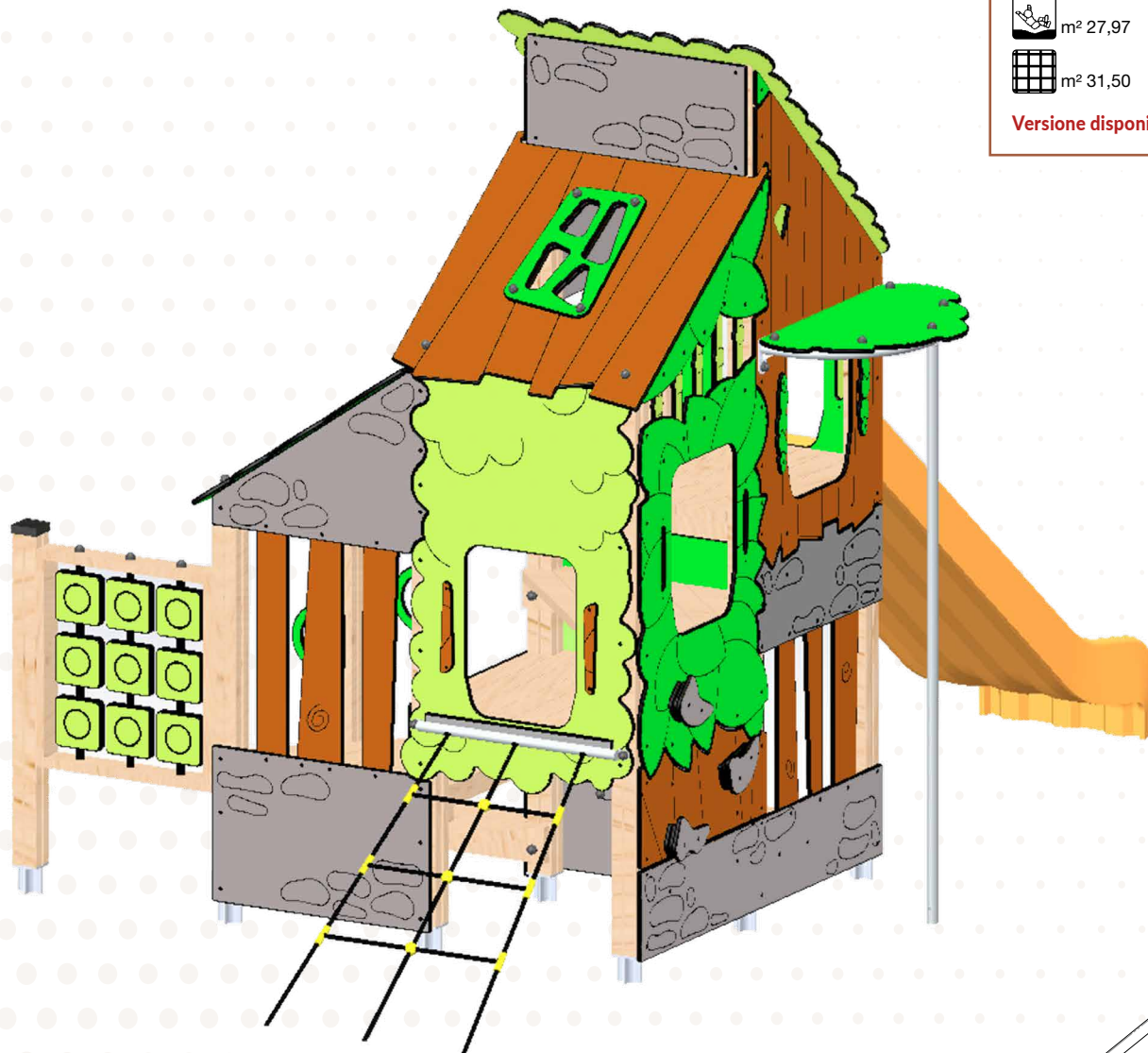

1,48h



m² 34,80



m² 27,97



m² 31,50

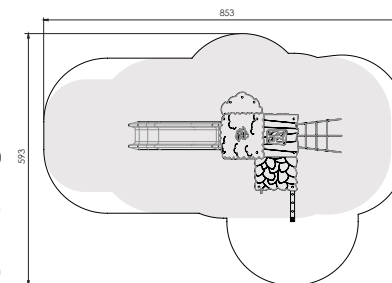

Versione disponibile con montanti in Alluminio e piani in HPL



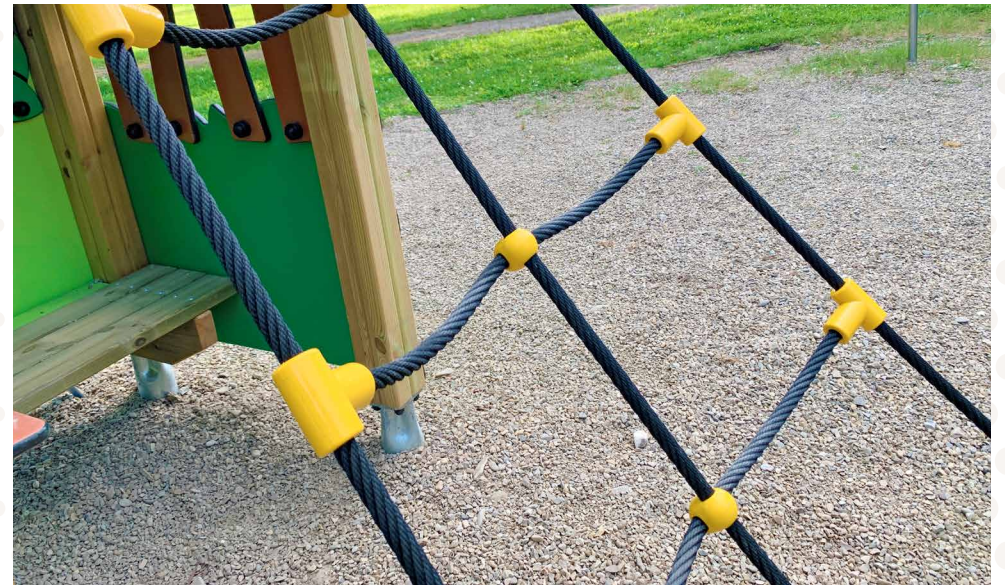

Pratolino

CAAD1104

COMPONENTI

Scivolo: H 90 cm

Pertica: H 90 cm

Pannello interattivo

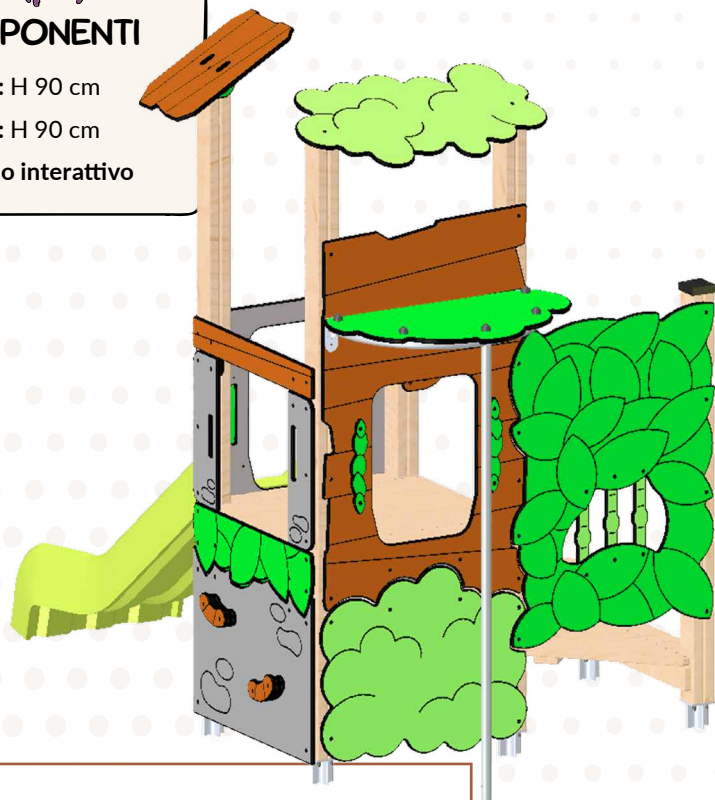

0,88h



m² 24,43



m² 20,12



m² 23,75

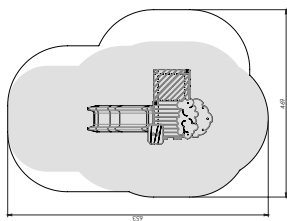

Versione disponibile con montanti in Alluminio e piani in HPL

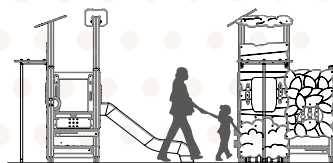

Boscanto

CAAD1105

COMPONENTI

Scivolo: H 90 cm

Sartia: H 90 cm

Pannello interattivo

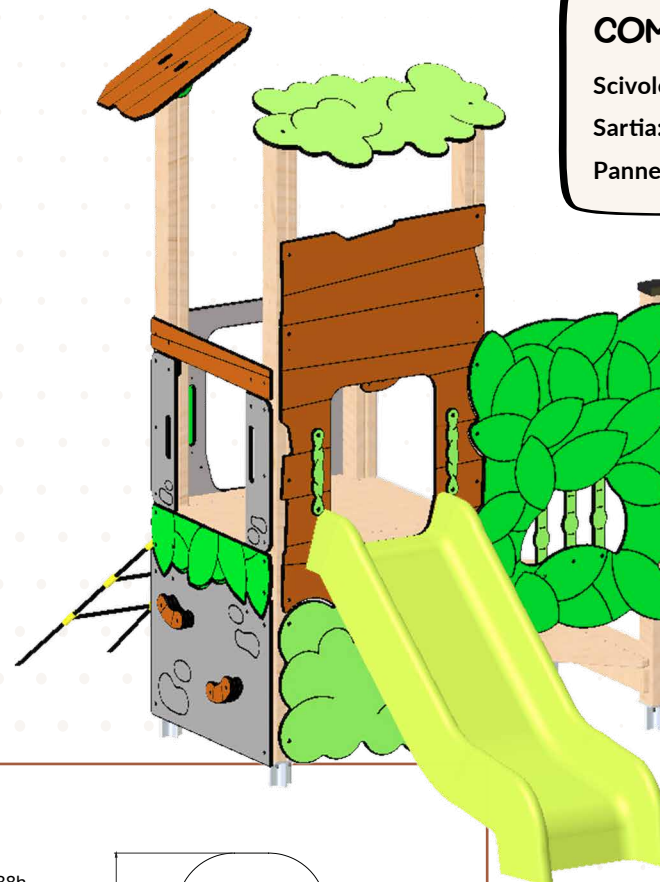

0,88h



m² 27,22



m² 21,93



m² 23,75

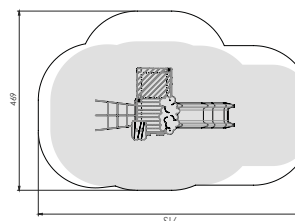

Versione disponibile con montanti in Alluminio e piani in HPL

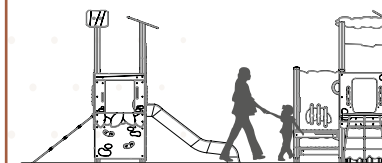

Campolucente

CAAD1106

Alberostrambo

CAAD1107

COMPONENTI

- Scivolo: H 150 cm
- Pertica: H 150 cm
- Sartia: H 150 cm
- Scala
- Pannello interattivo

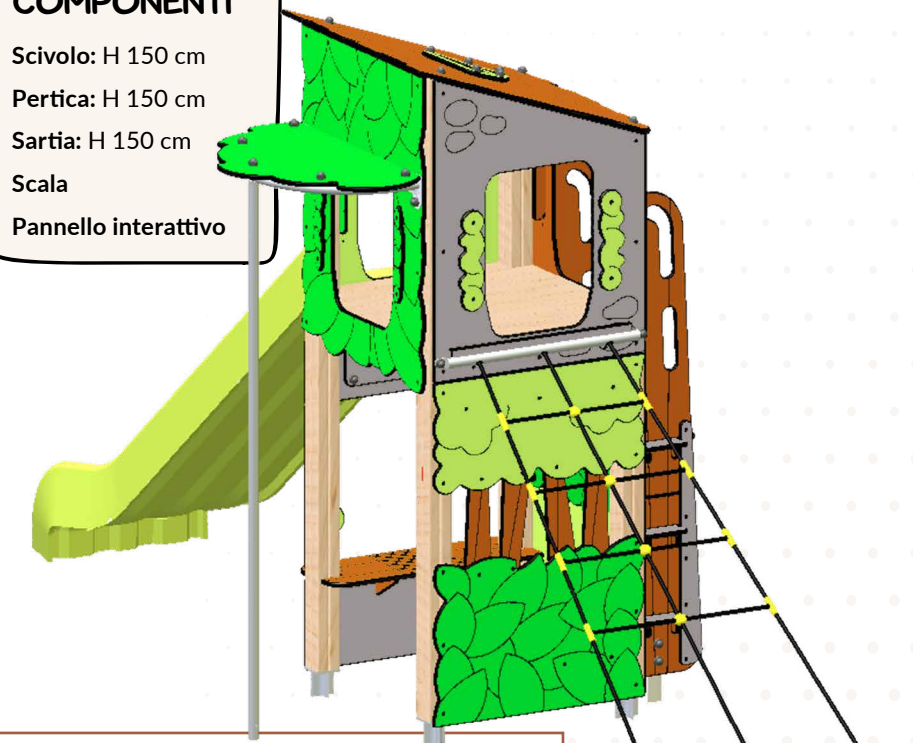

COMPONENTI

- Scivolo: H 150 cm
- Pertica risalita: H 150 cm
- Sartia: H 150 cm
- Scala
- Pannello interattivo

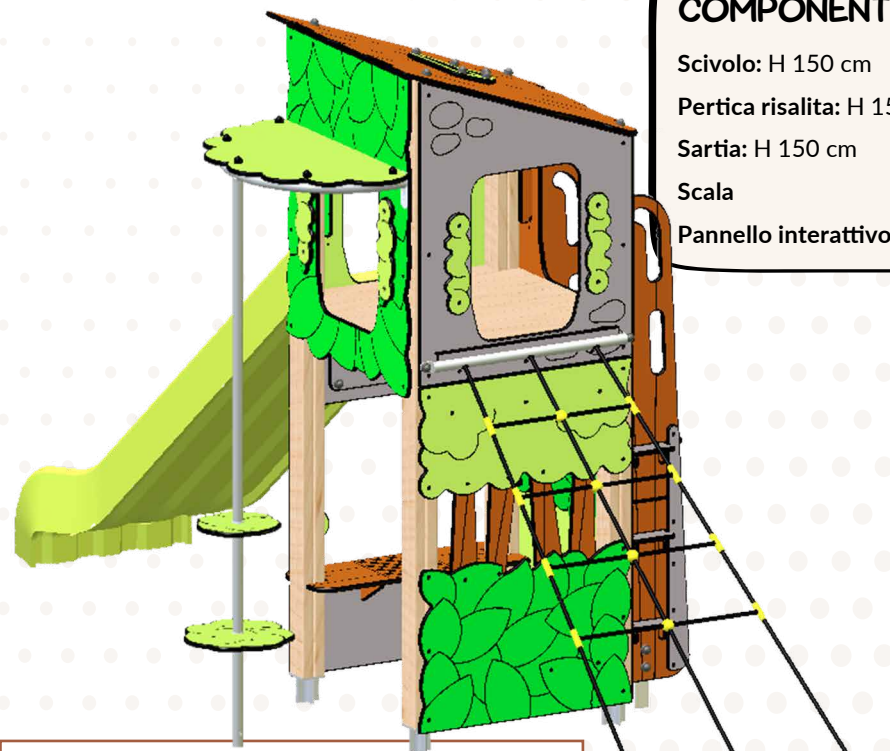

	1,48h
	m ² 31,66
	m ² 25,66
	m ² 29,50

Versione disponibile con montanti in Alluminio e piani in HPL

	1,48h
	m ² 32,22
	m ² 26,19
	m ² 30,25

Versione disponibile con montanti in Alluminio e piani in HPL

Boscobaracca

CAAJ1101

COMPONENTI

Sedute
Pannello interattivo

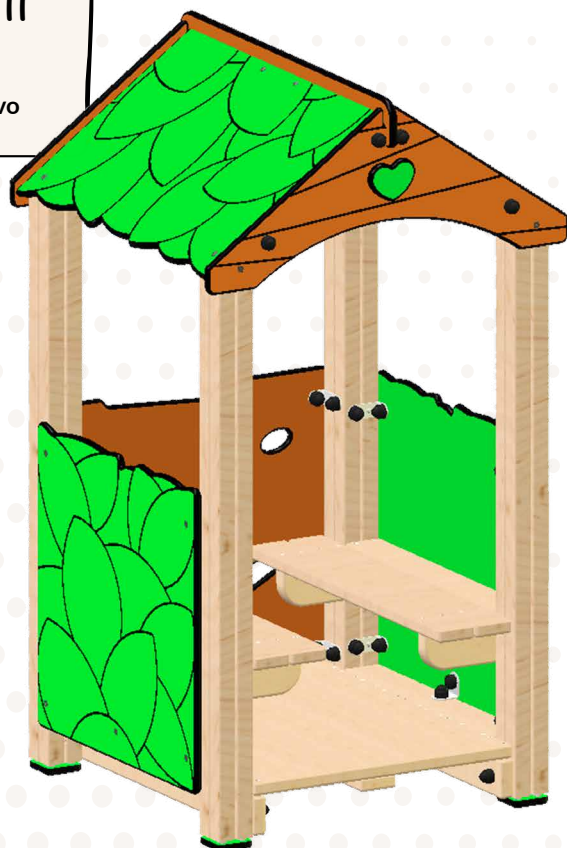

Giocapanna

CAAJ1102

COMPONENTI

Seduta
Banco vendita
Pannello interattivo

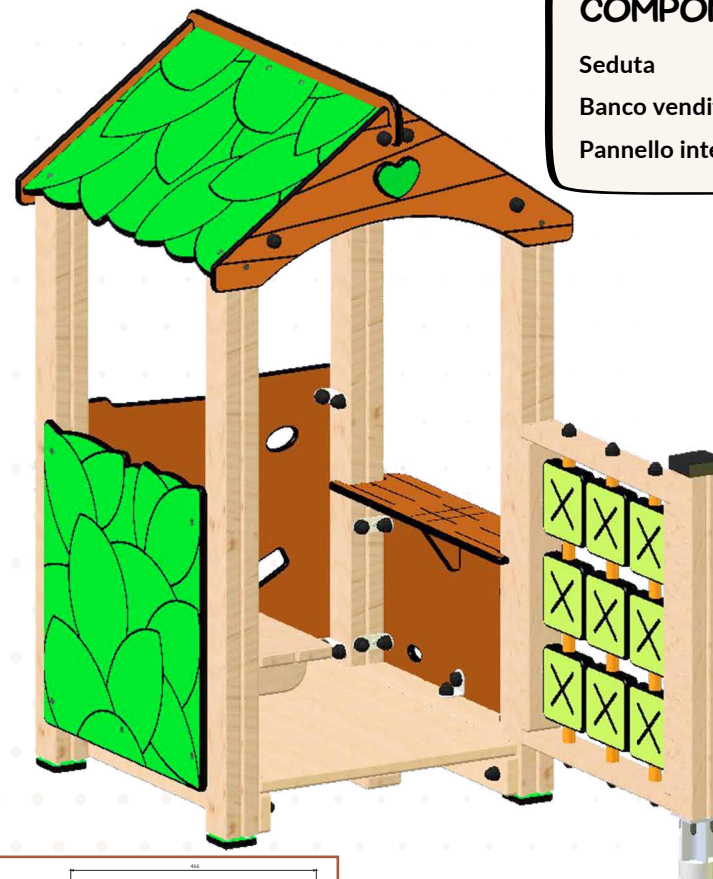

<0,60h



m² 28,49

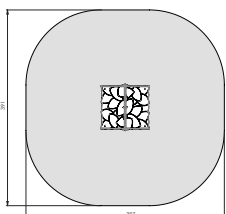

<0,60h



m² 28,49

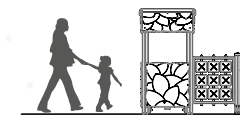
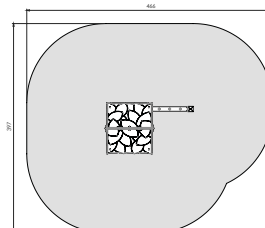

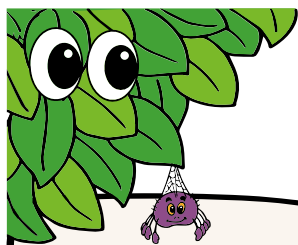

Dolce Abbraccio

 CAAP1001

COMPONENTI

- Piano fasciatoio
- Appendiabiti

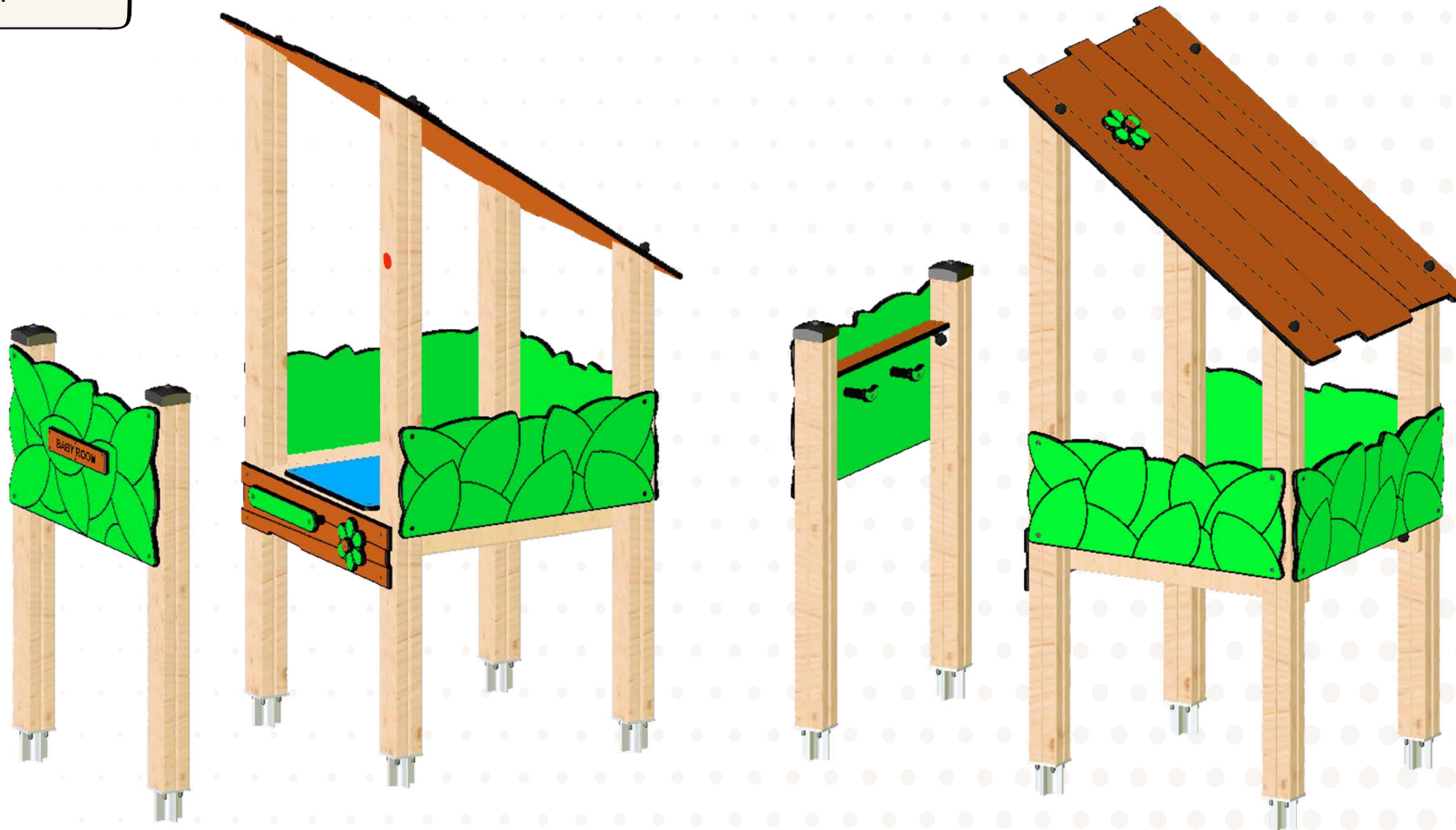
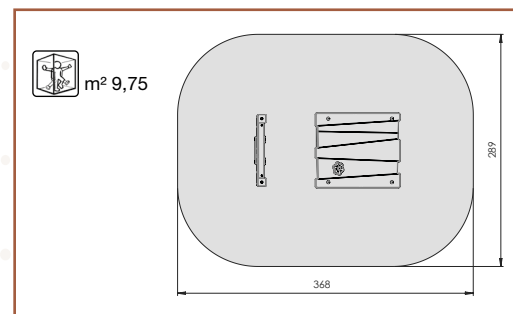

Cielazzurra

CAAE1001



1,22h



m² 24,25



m² 11,03



m² 13

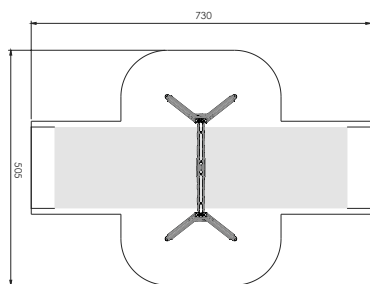

Versione disponibile con montanti in Alluminio e piani in HPL



Ariallegra

CAAE2001

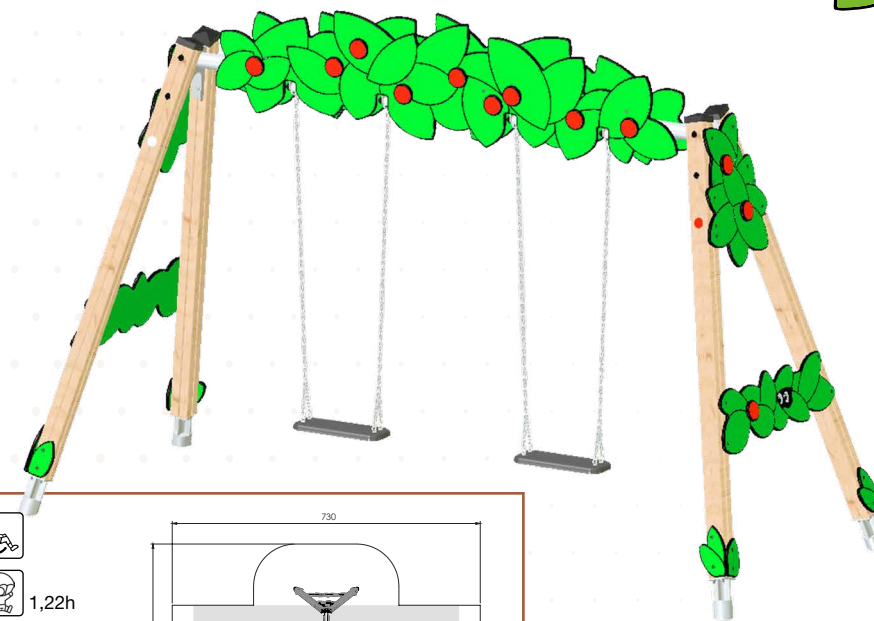

1,22h



m² 31,03



m² 18,90



m² 19,5

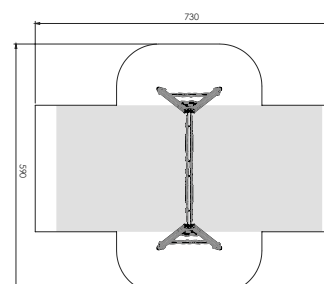

Versione disponibile con montanti in Alluminio e piani in HPL

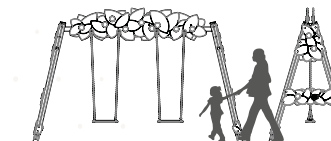

OPZIONI SEDUTE

La seguente lista è indicativa alla personalizzazione delle altalene con codice:
CAAE1001 - CAAE2001 - CAAE3001



Tavoletta "C"



Gabbia "D"



Doppio "Y"



Inclusivo "T"



Inclusivo Oplà "M"





Stringivento

CAAE1301

Volomatto

CAAE3001

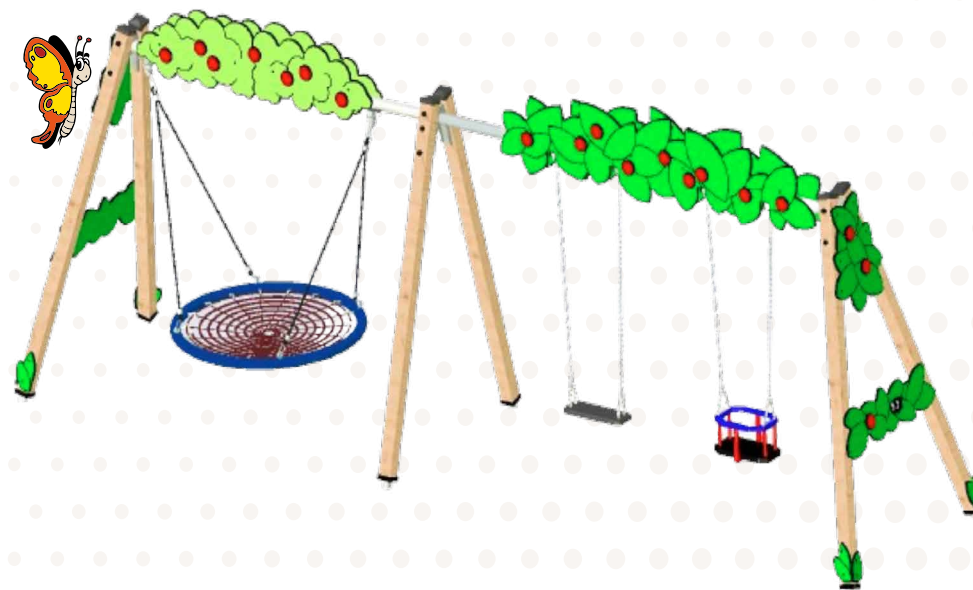

	1,22h
	m ² 25,99
	m ² 15,44
	m ² 16,25

Versione disponibile con montanti in Alluminio e piani in HPL



	1,22h
	m ² 55,40
	m ² 38,30
	m ² 37,13

Versione disponibile con montanti in Alluminio e piani in HPL

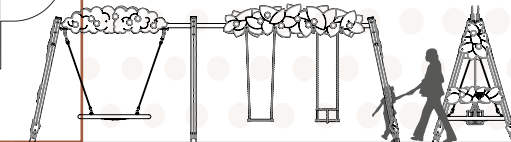



Zebretta

 CAAH1083

Pardo

 CAAH1082

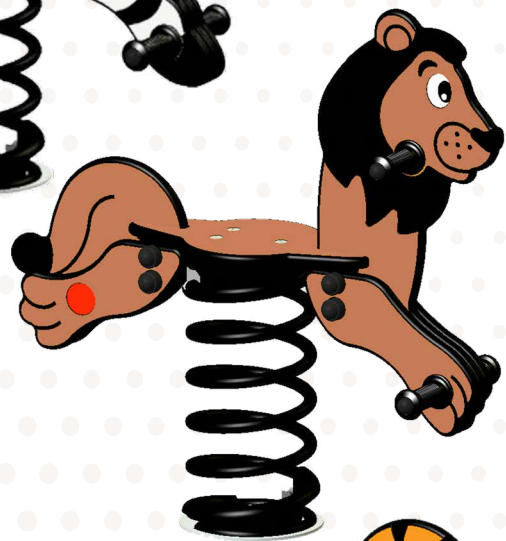

Leo

 CAAH1080







Tigro

 CAAH1081

GRRR



	<0,60h
	m ² 9,83
	m ² 9,83
	m ² 12

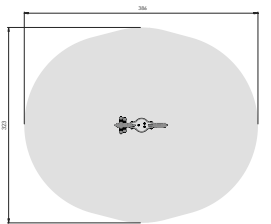





Biss





CAAH2050

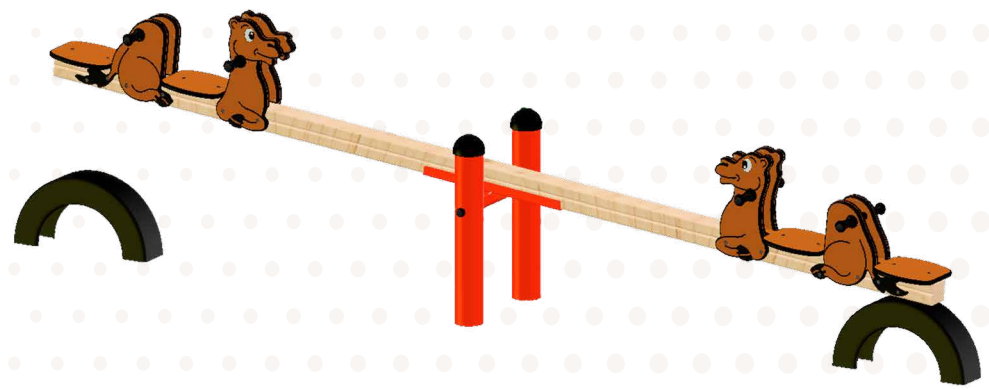
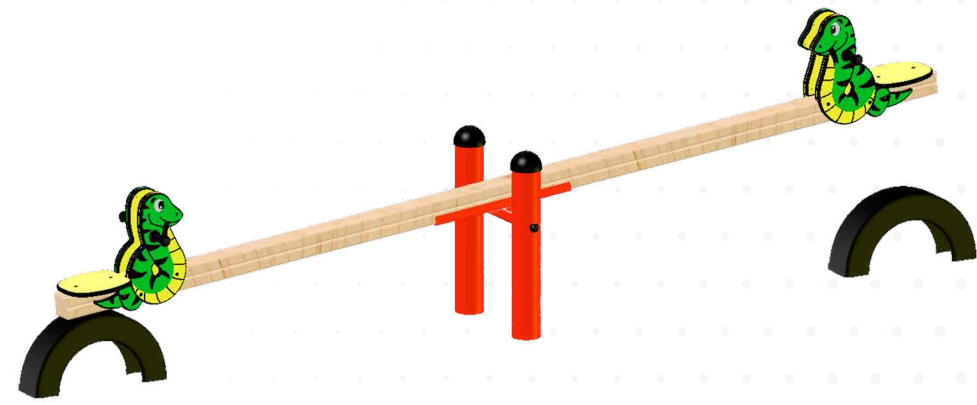

Dario

CAAH4050





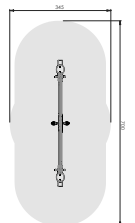

 0,80h
 m² 20,21
 m² 20,21
 m² 23,50

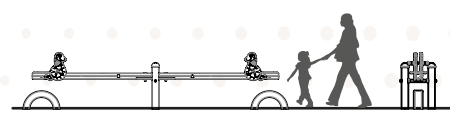

Versione disponibile con montanti in Alluminio e piani in HPL



 0,80h
 m² 20,21
 m² 20,21
 m² 23,50

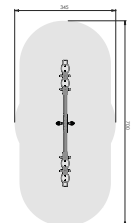

Versione disponibile con montanti in Alluminio e piani in HPL

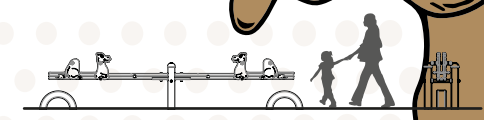



Baobab

CAAH1701



Oasi

CAAH1703

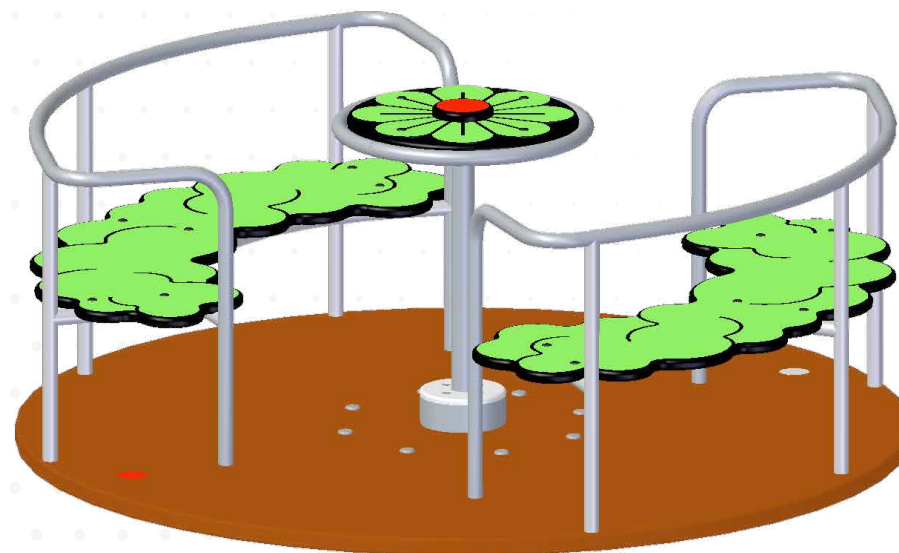
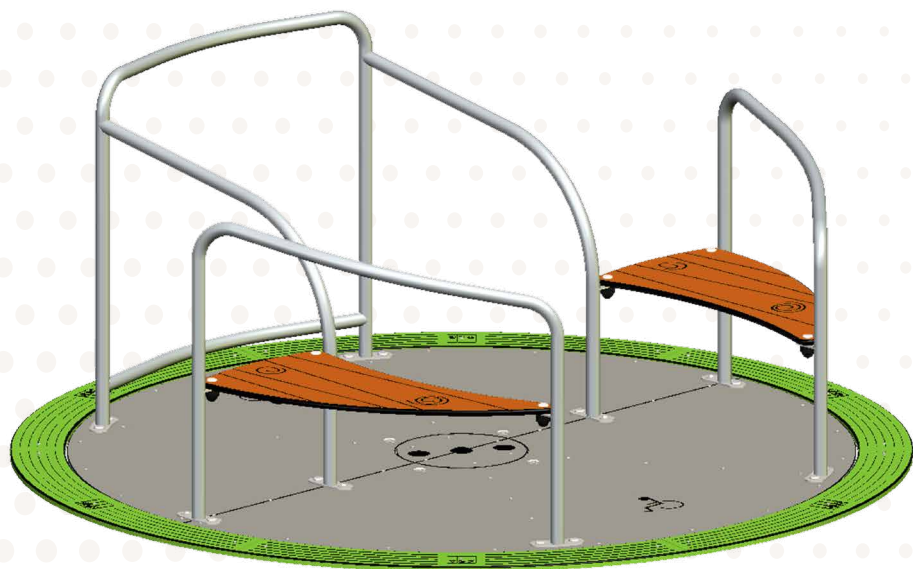

	0,82h
	m ² 33,40
	m ² 26,30
	m ² 28,50



	0,65h
	m ² 23,30
	m ² 21,65
	m ² 25,50

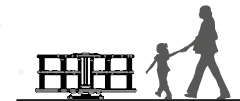

A series of horizontal dotted lines for writing, spanning most of the page width.

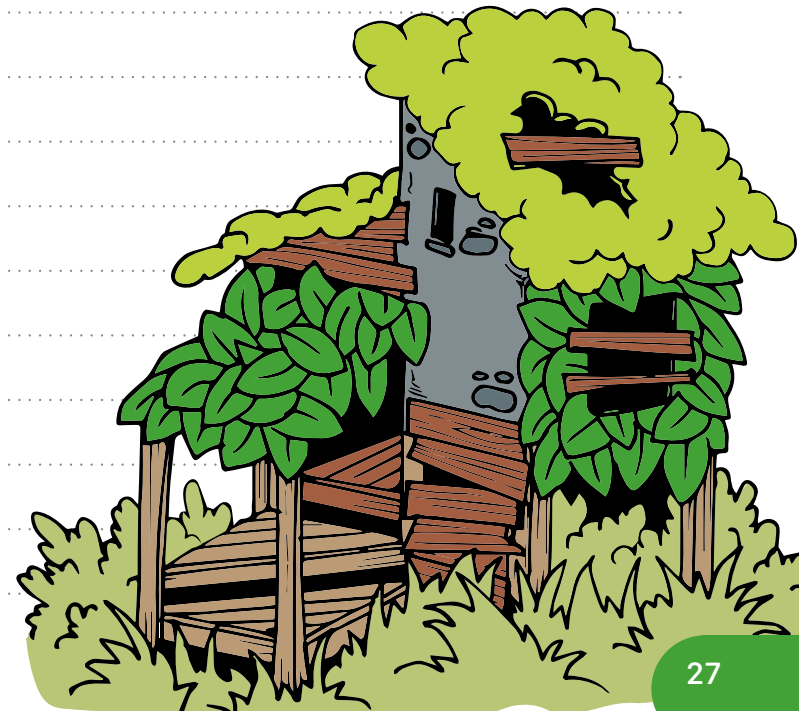



Dal 1984, il marchio **TLF**[®] si è impegnato a migliorare la vita dei bambini, favorendo e creando esperienze di gioco creative in armonia con l'ambiente.

In **TLF** progettiamo e produciamo attrezzature ludiche innovative, in grado di promuovere l'apprendimento e lo sviluppo attraverso opportunità di gioco, permettendo ai bambini di avere successo e guadagnare fiducia.

Per garantire ulteriormente un domani migliore, abbiamo sviluppato sistemi di lavoro e di scelta dei fornitori che si sono dimostrati vincenti nel contesto di un'azione responsabile, al fine di ridurre gli effetti del cambiamento climatico.

TLF è leader nel gioco Inclusivo e Sensoriale, con una serie estremamente vasta di articoli che permettono la creazione di aree gioco adeguate a tutte le esigenze.

Visitate il nostro sito web **TLF** all'indirizzo www.tlf.it per avere una spiegazione più dettagliata su come classifichiamo il livello di accessibilità degli articoli ludici **TLF**.

100%
progettato
e prodotto
in Italia



TLF s.r.l.

Via del Molino, 42 - Corsalone
52010 Chiusi della Verna (AR)

T. 0575 531 400

info@tlf.it - www.tlf.it



ISO 9001:2015

ISO 14001:2015

FSC[®]

TÜV Rheinland

CAM

RATING DI LEGALITÀ



Sistema di gestione della qualità dei processi aziendali.

Sistema di gestione finalizzato a ridurre al minimo l'impatto negativo dell'attività aziendale sull'ambiente.

Il *Forest Stewardship Council*[®] è un'organizzazione globale senza fini di lucro dedicata alla promozione della gestione responsabile delle foreste del mondo. Richiedi i nostri prodotti certificati FSC[®].

Certificazione della rispondenza dei prodotti a norma **UNI EN 1176**.

Certificato che individua prodotti che rispondono ai Criteri Ambientali Minimi.

Strumento volto alla promozione e all'introduzione di principi di comportamento etico in ambito aziendale.

TLF adotta le migliori tecniche di lavorazione e moderni processi produttivi per il trattamento del legno; nonostante ciò, essendo il legno stesso un materiale naturale igroscopico che risente delle variazioni delle condizioni ambientali, in casi del tutto particolari e limitati potrebbero talvolta verificarsi dei movimenti di ritiro e rigonfiamento nonché dei fenomeni fisiologici di fessurazione che comunque non ne compromettono l'integrità strutturale e la qualità.

Le caratteristiche tecniche, descrizioni, colori e altro sono da ritenersi puramente indicative. Le dimensioni dell'attrezzatura in questo catalogo sono soggette a variazioni di $\pm 5\%$ rispetto a quelle indicate. **TLF** si riserva il diritto di modificare ogni prodotto laddove sia necessario per migliorarne la qualità sia dal punto di vista delle dimensioni che della struttura.



SIAMO PRESENTI SU acquistinretepa.it